



Specification For Approval

Customer : _____
Description : _____ EC FAN _____
Customer Part No. : _____ Rev : _____
Delta Model No. : _____ GTB040EUD26R N1 _____ Rev : X03
Safety Model No. : _____ GTB040EUD26 _____
Sample Issue No. : _____
Sample Issue Date : _____ 03/01/2017 _____

Please send one copy of this specification back after you signed approval for production pre-arrangement

Approved by : _____

Date : _____

Delta Electronics, Inc.

No.252, Shangying Road, Guishan Industrial Zone,
Taoyuan City, 33341, Taiwan

TEL : +886-3-359-1968

FAX : +886-3-359-1991

*** SAMPLE HISTORY ***

CUSTOMER :

CUSTOMER P/N :

DELTA MODEL : GTB040EUD26R N1

REV	DESCRIPTION	DRAWN	CHECKED		APPROVED	ISSUE DATE
			ME	EE		
X03	ISSUE SPEC.	邱靜美 03/01'17	邱靜美 03/01'17	林科亦 03/01'17	顏承偉 03/01'17	03/01'17

Electronically Commutated (EC) Fan

Centrifugal Fan

φ 404 x 257 mm



Delta Electronics, Inc.
 No.252, Shangying Road, Guishan
 Industrial Zone, Taoyuan City, 33341,
 Taiwan
 TEL: +886-3-359-1968
 FAX: +886-3-359-1991
www.deltaww.com



Technical features

Input Side	
Nominal Voltage	1~ 230Vac 50/60Hz
Input Source	1~ 200Vac - 277Vac
Power @ Free air	530 W
Power @ Max. load	800 W
Output Side	
Speed (RPM)	1750
Qmax. (CMH / CFM)	5692 / 3350
Pmax. (Pa / inAq)	690 / 2.77
Noise (dB-A) @ Qmax.	77.5
Functions	
Active power factor correction	
Control input 0-10VDC / PWM / 4-20mA.	
Output +10VDC (±10%), max. 10mA.	
Control voltage output: 0-10VDC.	
RS485 control bus	
Alarm relay, Locked rotor protection, Soft start.	
Speed telling, Frequency generator signal.	
Voltage / Current monitoring.	

Physical	
Rotation Direction	CW, Seen on rotor
Material (Impeller / Frame)	Aluminum sheet / Die-cast aluminum
Bearing system	Ball bearings
Weight (kg)	11.3
Electrical leads	Via terminal block
Environmental	
Operating temperature range	-25 ~ +60 °C
Storage temperature range	-40 ~ +70 °C
Safety	
Safety	UL; cUL; TUV
IP Level	IP54
EMC	EN61000-6-2/4 , EN61000-3-2/3
Protection class	I
Insulation class	B
Leakage current	≤ 3.5 mA
Motor protection	Over temperature protected
Life expectancy	60,000 hrs at 40 °C / 15 ~ 65 %RH

NOTE: Delta reserves the right to change specifications and other product information without prior notice.

P & Q curves

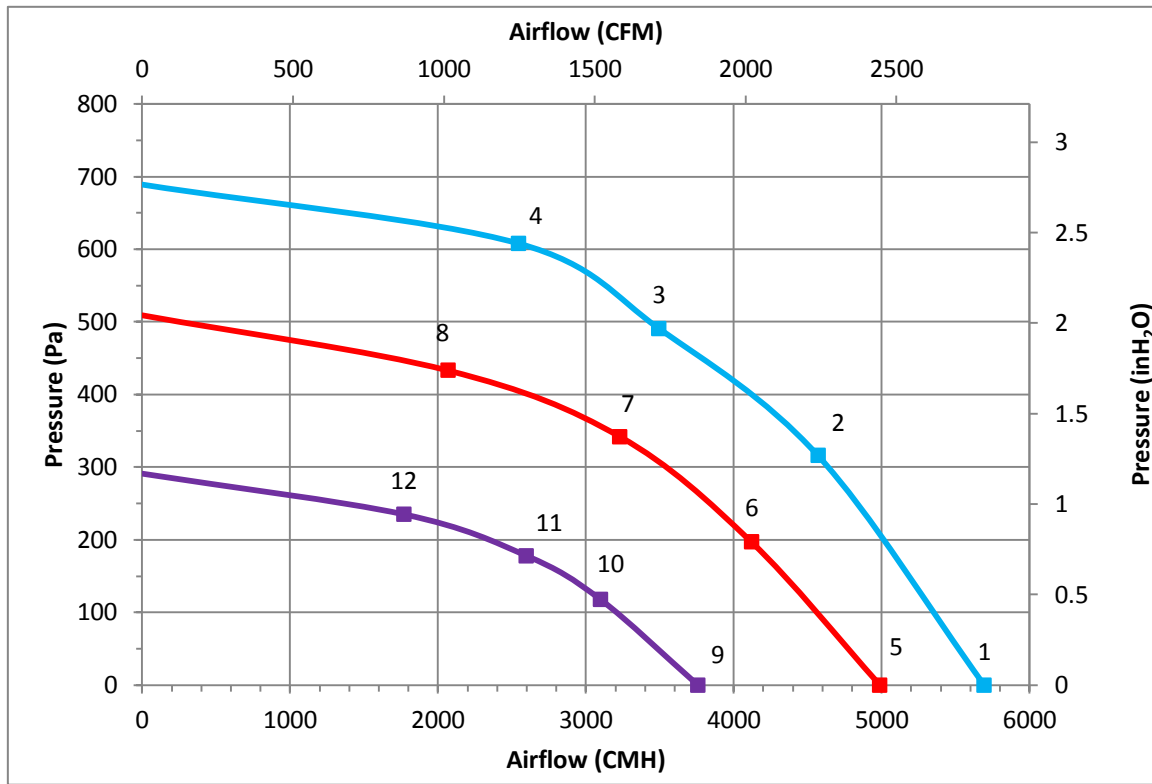

Measure data:

	P [Pa]	Q [CMH]	N [R.P.M.]	P1 [W]	I [A]	Lp [dB(A)]
1	0	5693	1750	530	2.34	77.5
2	316	4569	1750	775	3.40	
3	491	3493	1744	800	3.51	
4	608	2543	1760	767	3.37	
5	0	4988	1525	370	1.66	75.5
6	197	4119	1528	496	2.19	
7	342	3229	1529	538	2.37	
8	433	2068	1527	483	2.14	
9	0	3757	1160	166	0.82	70.0
10	118	3097	1156	223	1.04	
11	178	2598	1158	238	1.11	
12	235	1769	1164	229	1.07	

Test Condition :

- Input Voltage: Nominal Voltage
- Temperature : Room Temperature
- Humidity : 65%RH
- Measured with inlet cone.
- Noise (Lp) is measured at a distance of one meter from the inlet side.

Dimension drawing

Label :

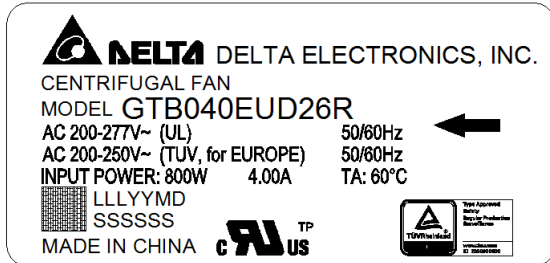

Fan :

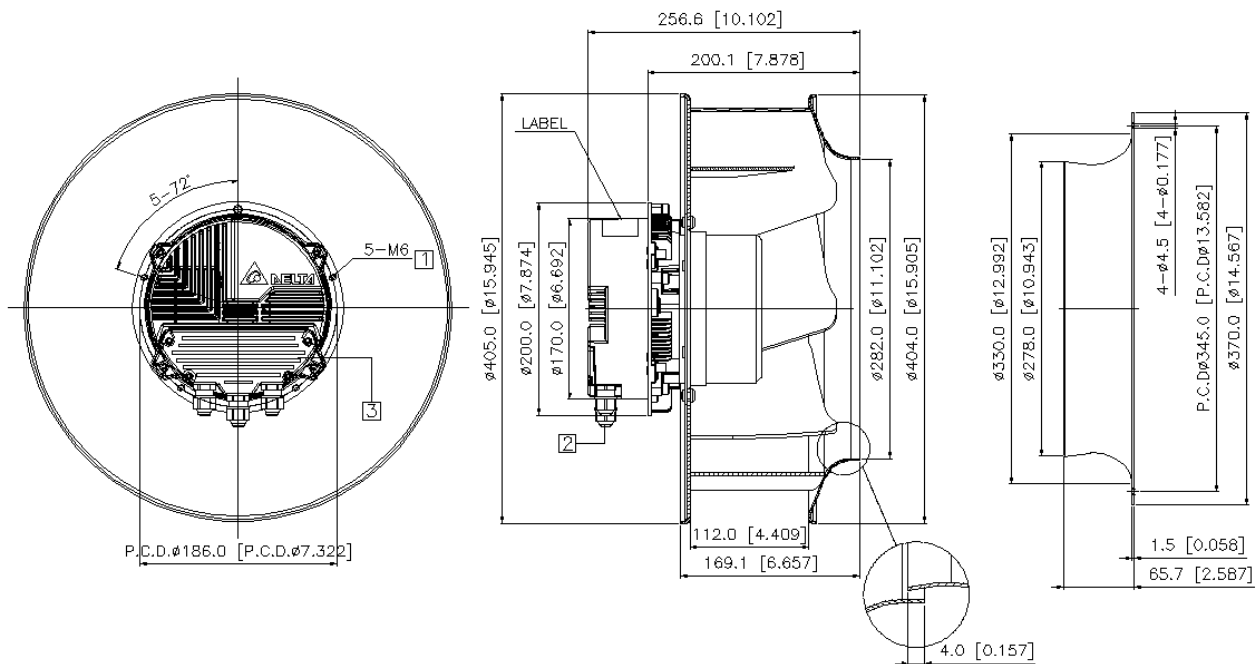

Note :

1. Depth of screw : 12 ~16 mm.
2. Cable Diameter : $\phi 6.0$ ~ $\phi 10.0$ mm
3. Open the cover and refer to definition of terminal block.

UNIT : mm [INCH]

Definition of terminal block

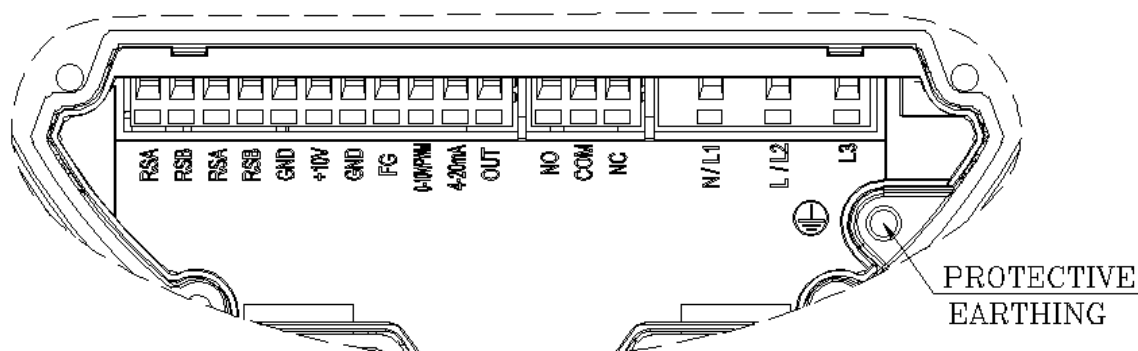

	Text	Functions
Power	N/L1	Neutral / AC mains
	L/L2	AC mains
	L3	--
Status	NO	Alarm relay, open by failure
	COM	Alarm relay, common (2A/250VAC)
	NC	Alarm relay, close by failure
Signal	RSA	RS485-A
	RSB	RS485-B
	RSA	RS485-A
	RSB	RS485-B
	GND	Ground
	+10V	+10V output, MAX 10mA (For external potentiometer)
	GND	Ground
	FG	Frequency generator (FG) signal
	0-10V/PWM	Speed control ,input 0-10VDC
	4-20mA	Speed control ,input 4-20mA
	OUT	Control voltage output 0-10VDC (For external potentiometer)

Lead wire connection:

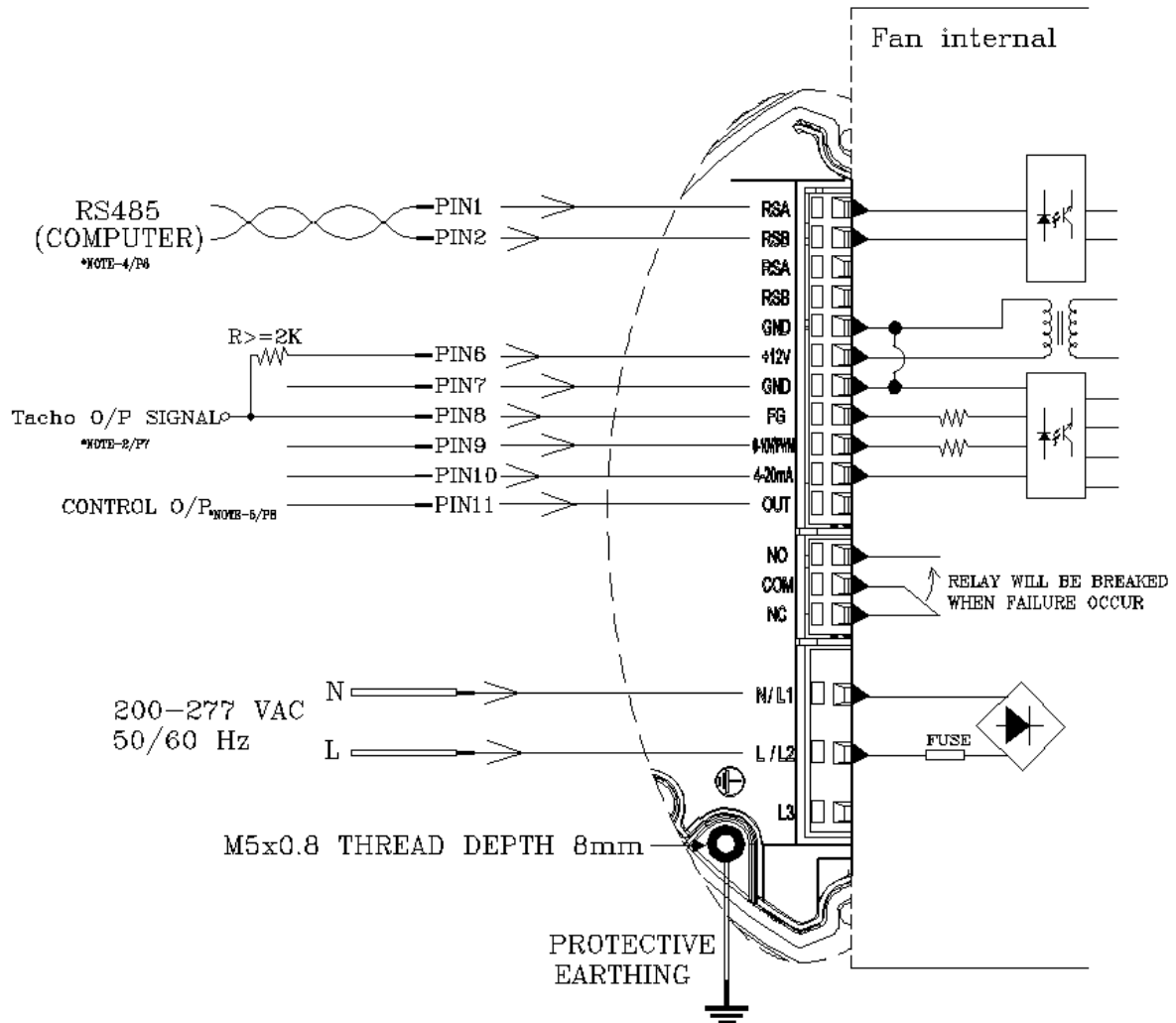

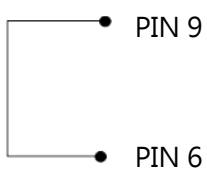
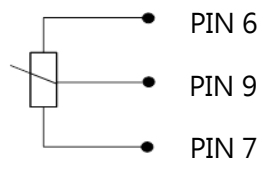
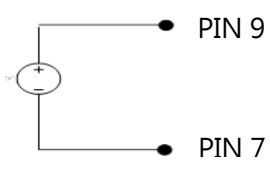
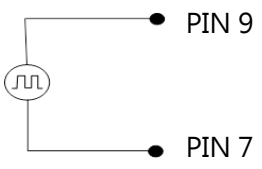
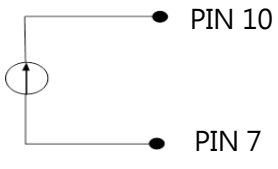
Speed setting	
<p>Full Speed</p> 	<p>Short PIN6 & PIN9 Fan will run full speed.</p>
<p>Voltage Control A</p> 	<p>Connector 1-10kΩ variable resistor Between +10VDC with GND and 0-10V/PWM Turn the variable resistor · can change the '0-10V/PWM' voltage (0...10V) °</p>
<p>Voltage Control B</p> <p>0-10V DC Source</p> 	<p>Use voltage source support 0~10VDC voltage DC+ : connector PIN9(+) DC - : connector PIN7(-)</p>
<p>PWM Control</p> <p>PWM Generator</p> 	<p>PWM duty control PWM amplitude is 10VDC(+/-5%) Frequency Range is 100Hz...100kHz -PWM duty higher than 15%, fan start up ° -PWM duty lower than 5%, fan stop °</p>
<p>Current Control</p> <p>4-20mA Current Source</p> 	<p>4~20mA Current Control Open 0-10V/PWM PIN - Lower than 4.5 mA → Fan Stop - Higher than 6.0 mA → Fan Start up - Higher than 19.5 mA → Maximum Speed</p>

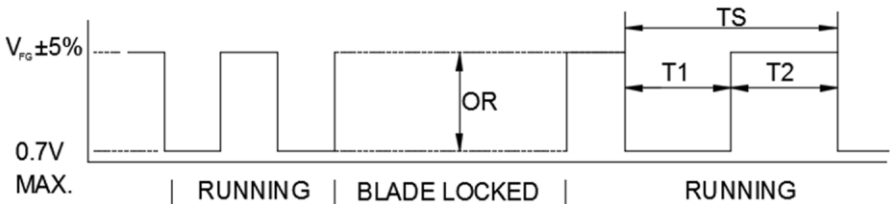
Signal function																
RS485 control function	<p>RS485 control function</p> <ul style="list-style-type: none"> -Select the control mode of speed, fixed speed or fixed PWM duty -Speed and power consumption feedback. -Allow multiple FANs control and status patrol. 															
Control O/P	<p>The analog signal level is the derivative of current control level.</p> <table border="1"> <thead> <tr> <th>Current (mA)</th> <th>Control O/P (VDC) (REF)</th> </tr> </thead> <tbody> <tr> <td>4.0</td> <td>0.2</td> </tr> <tr> <td>6.2</td> <td>1.47</td> </tr> <tr> <td>13.7</td> <td>5.96</td> </tr> <tr> <td>18.7</td> <td>8.95</td> </tr> <tr> <td>20.0</td> <td>9.65</td> </tr> </tbody> </table>	Current (mA)	Control O/P (VDC) (REF)	4.0	0.2	6.2	1.47	13.7	5.96	18.7	8.95	20.0	9.65			
Current (mA)	Control O/P (VDC) (REF)															
4.0	0.2															
6.2	1.47															
13.7	5.96															
18.7	8.95															
20.0	9.65															
Voltage/PWM control	<p>The speed comparison will control level</p> <table border="1"> <thead> <tr> <th>Voltage (V)</th> <th>PWM (%)</th> <th>Speed (RPM) (REF)</th> </tr> </thead> <tbody> <tr> <td>0</td> <td>0</td> <td>0</td> </tr> <tr> <td>1.5</td> <td>15</td> <td>330±50RPM</td> </tr> <tr> <td>6.0</td> <td>60</td> <td>1170±8%</td> </tr> <tr> <td>9.5</td> <td>95</td> <td>1750±5%</td> </tr> </tbody> </table>	Voltage (V)	PWM (%)	Speed (RPM) (REF)	0	0	0	1.5	15	330±50RPM	6.0	60	1170±8%	9.5	95	1750±5%
Voltage (V)	PWM (%)	Speed (RPM) (REF)														
0	0	0														
1.5	15	330±50RPM														
6.0	60	1170±8%														
9.5	95	1750±5%														
Current control	<p>The speed comparison will control level</p> <table border="1"> <thead> <tr> <th>Current (mA)</th> <th>Speed (RPM) (REF)</th> </tr> </thead> <tbody> <tr> <td>4.0</td> <td>0</td> </tr> <tr> <td>6.2</td> <td>335±50RPM</td> </tr> <tr> <td>14.0</td> <td>1200±8%</td> </tr> <tr> <td>19.5</td> <td>1750±5%</td> </tr> </tbody> </table>	Current (mA)	Speed (RPM) (REF)	4.0	0	6.2	335±50RPM	14.0	1200±8%	19.5	1750±5%					
Current (mA)	Speed (RPM) (REF)															
4.0	0															
6.2	335±50RPM															
14.0	1200±8%															
19.5	1750±5%															
Alarm state	<p>NO and COM will OPEN ; NC and COM will CLOSE.</p>															
FG	<p> $V_{CE(sat)} = 0.7V \text{ MAX.}$ $V_{FG} = 30.0V \text{ MAX.}$ $I_C = 5mA \text{ MAX.}$ $R \geq V_{FG} / I_C$ </p> <p>Frequency generator waveform</p>  <div style="border: 1px solid black; padding: 5px; width: fit-content; margin: 10px auto;"> <p> $N=R.P.M$ 1 PULSE PER REVOLUTION $TS=60/N(SEC)$ $T1=T2=1/2 TS$ </p> </div>															

Control Voltage VS. RPM Curve

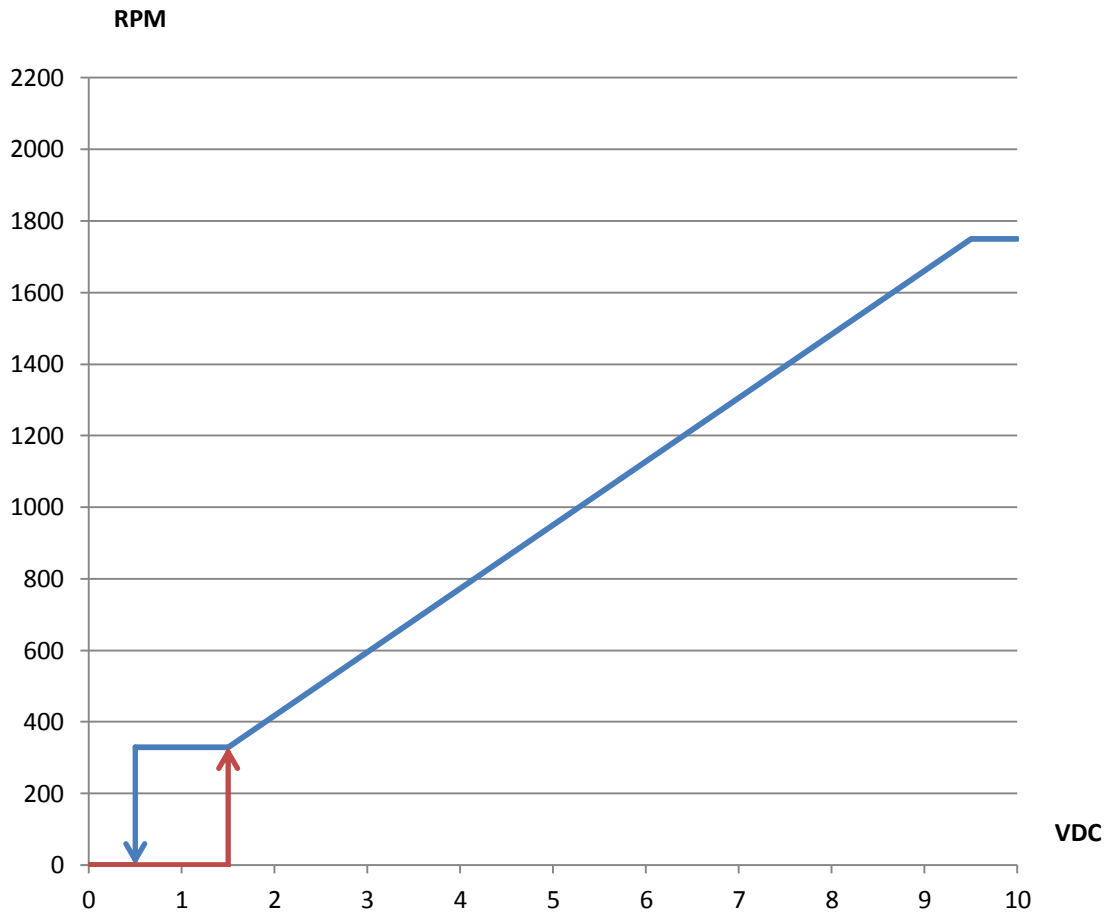

Voltage(VDC) , PWM duty (%), 4~20mA table

Voltage	0	0.5	1	1.5	2	3	4	5	6	7	8	9	10	VDC
PWM duty	0	5	10	15	20	30	40	50	60	70	80	90	100	%
4~20 mA	4	5	5.6	6	7.2	8.8	10.4	12	13.6	15.2	16.8	19	20	mA