



## Specification and Manual

Customer: \_\_\_\_\_  
Description:   Air Conditioner for Equipment    
Customer Part No.: \_\_\_\_\_ Rev.: \_\_\_\_\_  
Delta Model No.:   HEC0600AFS   Rev.:   02    
Sample Date Code: \_\_\_\_\_  
Sample Issue Date:   Sep.02 2020  

Please send one copy of this specification back after  
you signed approval for production pre-arrangement

Approved by: \_\_\_\_\_

Date: \_\_\_\_\_

DELTA ELECTRONICS, INC.  
252, SHANG YING ROAD, KUEI SAN  
TAOYUAN CITY 333, TAIWAN

TEL: 886-(0)3-3591968  
FAX: 886-(0)3-3591991

Part no.:

Delta model no.: HEC0600AFS

---

## Table of content

Description.....	3
Packing & Shipping.....	3
Safety Notes.....	3
1. Product Instruction .....	7
1-1. General Description .....	7
1-2. Main Feature & Model Number .....	7
1-3. Dimension.....	9
1-4. Mounting plane Cutout .....	10
1-5. Configuration & Maintenance .....	11
1-6. Thermal and Airflow .....	13
3. Environmental Condition .....	17
4. Reliability Table.....	17
5. Safety Certification .....	17
6. Accessory .....	17
7. Parameters .....	18
7-1 Parametric Setup.....	18
7.2 Self-Test.....	19
7.3 Alarm Logs & Fault Processing .....	19
8. Installation Notice .....	22
9. Reclaim .....	22
10. Versions .....	23

Part no.:

Delta model no.: HEC0600AFS

---

## Description

This document is an installation and the characteristics of Delta HEC series. Before installing the unit, please read this manual thoroughly, and following the instructions contained in it. The document is the exclusive property of Delta Electronics, Inc. it should not be distributed, reproduced, or any other format without prior permission of Delta. Specifications are subject to change without notice.

## Packing & Shipping

During handling or transport, air conditioner must be kept in upward position, “**NOT**” inverted, flat, or subject to excessive tilt and collision. The air conditioner is a precision instrument; it should be handled and transported with care. Do not stand on the box, or place heavy objects on top of the box. Pay attention to the below icons on the package.

If air conditioner is toppled, slanted or dropped, follow these steps: a. stand unit up for 12 hours to ensure refrigerant pressure stability, b. power on the unit and execute self-test to make sure no alarm condition, c. keep the air conditioner running for 1 hour to make sure there is no abnormal acoustic noise.

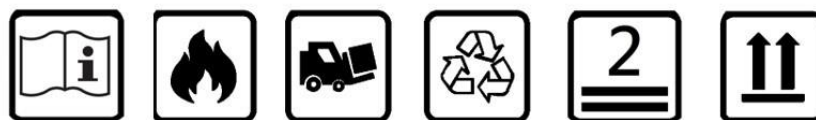

## Safety Notes

Please read the safety notes carefully before installing the air conditioner, and be sure to install it correctly. After completing installation, check that the unit operates properly during start-up operation.

Meaning of WARNING and CAUTION notices:

 **Warning:**

Failure to follow these instructions properly may result in personal injury or loss of life.

 **Caution:**

Failure to observe these instructions properly may result in property damage or personal injury, which may be serious depending on the circumstance.

Part no.:

Delta model no.: HEC0600AFS

---

 **Warning:**

1. Installation work and electrical wiring should be done only by qualified personnel in accordance with all applicable codes, standards and national wiring regulations.
2. Use this unit only in the manner intended by the manufacturer. If you have questions, please contact the manufacturer.
3. Install the air conditioner in accordance with the instructions in this installation manual. Improper installation may result in water leakage, electric shock or fire.
4. Make sure that all wiring is secured, that specified wires are used, and there is no strain on the terminal connections or wires.
5. If refrigerant gas leaks during installation, ventilate the area immediately. Do not directly touch refrigerant that has leaked from refrigerant pipes or other areas, as there is a danger of frostbite.
6. Before serving or cleaning unit, switch power off and disconnect power supply.
7. When cutting or drilling into wall or ceiling, do not damage electrical wiring or hidden utilities.
8. Be sure to use only the specified accessories and parts to complete installation.
9. Protective grounding connection: The enclosure must be grounded at the protective ground terminal. Use 1.5 mm<sup>2</sup> (18AWG) wire and use spring washer to avoid loosening.
10. The air conditioner should not be accessible to the general public.
11. The installation must contain a device to disconnect all poles of the air conditioner from the power supply. The contact distance in all poles must be 3 mm minimum.
12. To reduce the risk of electrical shock: Means for disconnection must be incorporated in the fixed wiring in accordance with the wiring rules.
13. This appliance is intended for use only by qualified personnel.
14. That the appliance shall be installed in accordance with national wiring regulations.

Part no.:

Delta model no.: HEC0600AFS

---

 **Caution :**

1. Install the air conditioner on a wall or door strong enough to withstand the weight of the unit.
2. Do not block the air inlets or exits.
3. Do not install the air conditioner at any place where there is a danger or flammable gas leakage.
4. Arrange the drain to ensure complete drainage.
5. To avoid injury, do not touch the air inlet or aluminum fins of the unit.
6. Watch your step at the time of fin cleaning or air conditioner inspection.
7. Do not topple the air conditioner while moving or in storage.
8. The hole in the bottom of the air conditioner should be connected to a sealed container through a drain pipe.
9. This appliance is not to be used by any persons with reduced physical, sensory or mental capabilities, or lack of experience and knowledge, unless they have been given proper supervision or instruction.
10. Children should be prevented from playing with the appliance.

Part no.:

Delta model no.: HEC0600AFS

Specification for Approval

Customer :

Description : Air conditioner for Equipment with 600 W Rated Cooling Capacity

Customer P/N :

Rev. :

Delta model no. : HEC0600AFS

Rev. : 02

Sample revision. :

Date Code :

Sample issue date :

Quantity :1 pc

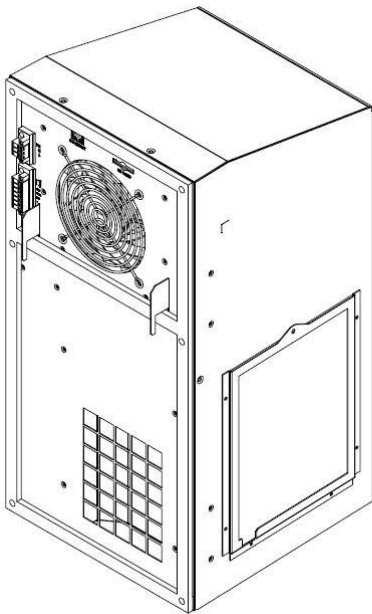

INTERNAL

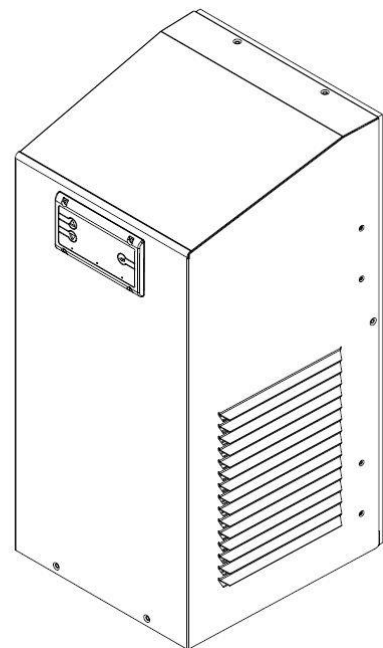

EXTERNAL

Part no.:

Delta model no.: HEC0600AFS

## 1. Product Instruction

### 1-1. General Description

HEC0600AFS is a AC air conditioner with 115VAC power input, it is designed for UL TYPE 12 sealed outdoor telecom cabinet to provide stable and optimum internal conditions for equipment and avoid hotspot inside the cabinet.

HEC X1 A F S  
(1) (2)(3) (4) (5)

No	Item	Digit	Specification
(1)	Product Message	HEC	Compressor Air Conditioner
(2)	Cooling Capacity	X1	X1=0600
(3)	Operation Voltage	A	AC 115V for door
(4)	Air condition type	F	F= Fix speed
(5)	Product Version	S	N/A

### 1-2. Main Feature & Model Number

Dimensions, Weight & Mounting method		
Dimension (H x W x D) (Body only)	mm (inch)	508 x 254 x 254 (20 x 10 x 10)
Application		Indoor / Outdoor
Weight	Kg (lbs)	15.5(34.2)
Mounting Method		Side mount
Color (optional)		RAL7035
Environmental Protection & Performance		
Operating Temperature Range	°C (°F)	-10 to +55 ( 14 to +131)
Operating Humidity		External: 0~100% RH Internal: 0~80% RH
Storage Temperature	°C (°F)	-40 to +70 (-40 to +158)
Storage Relative Humidity	RH	5~95%
Refrigerant		R134a, 160±10 g
Protection for Dust ,Wind and Water (External)		UL 50E TYPE 12
Noise (1.0m)	dB-A	63
Operating Status	N/A	LED Indicator / Display Board
Cooling Capacity & Operational Data		
Cooling Capacity at L35/L35 (50/60HZ)	W (Btu/hr)	500(1707)/600(2049)
Cooling Current at L35/L35(50/60Hz)*	A	3.4/ 2.6
Power & Range		
Input Voltage	VAC/Phase/Frequency	115/1/(50/60)

Part no.:

Delta model no.: HEC0600AFS

Input Voltage Range	VAC	104~126
Locked Rotor Current (50/60Hz)	A	8.8
Rated Current	A	4.3
Minimum circuit ampacity (MCA)	A	4.75
Maximum rating of overcurrent protective device (MOP)	A	15
Alarm	N/A	Dry Contact Output
<b>Key Components</b>		
Controller		Built-in Smart Controller
Fans		Delta High Efficiency Fans
Compressor		Rotary

\*Followed thermal balancing test of DIN3168

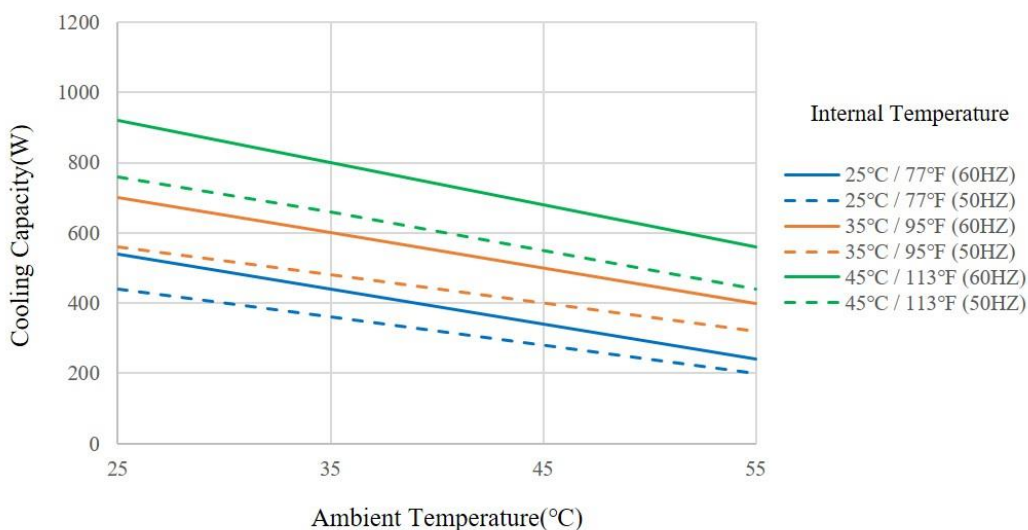

**Cooling Capacity with Varied Temperature**

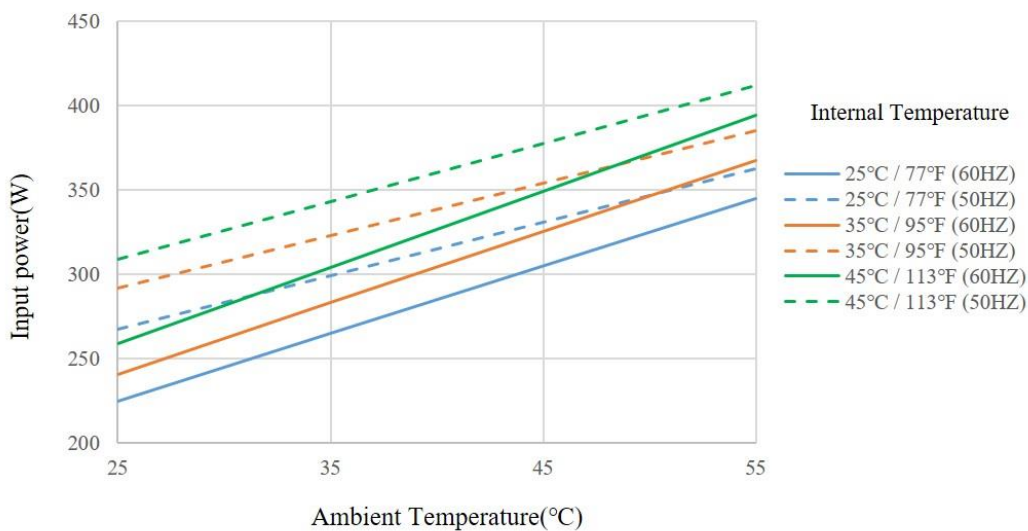

**Power Consumption with Varied Temperature**



Part no.:

Delta model no.: HEC0600AFS

### 1-3. Dimension

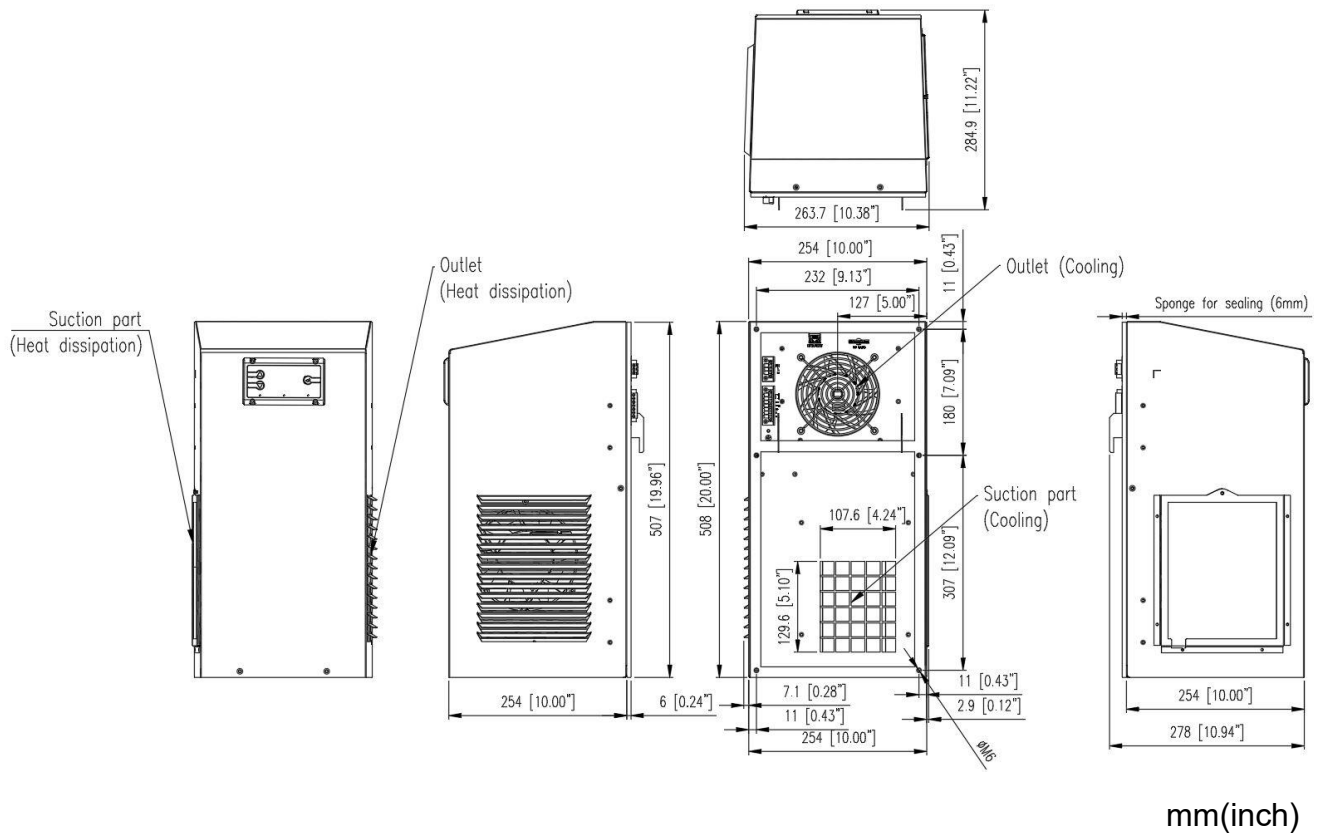

(1) Material: Case SGCC Sheet.

(2) Finish: Powder coating 75 uM Min., Color RAL 7035.

(3) Dimensional Tolerance:  $\pm 1$  mm

Part no.:

Delta model no.: HEC0600AFS

### 1-4. Mounting plane Cutout

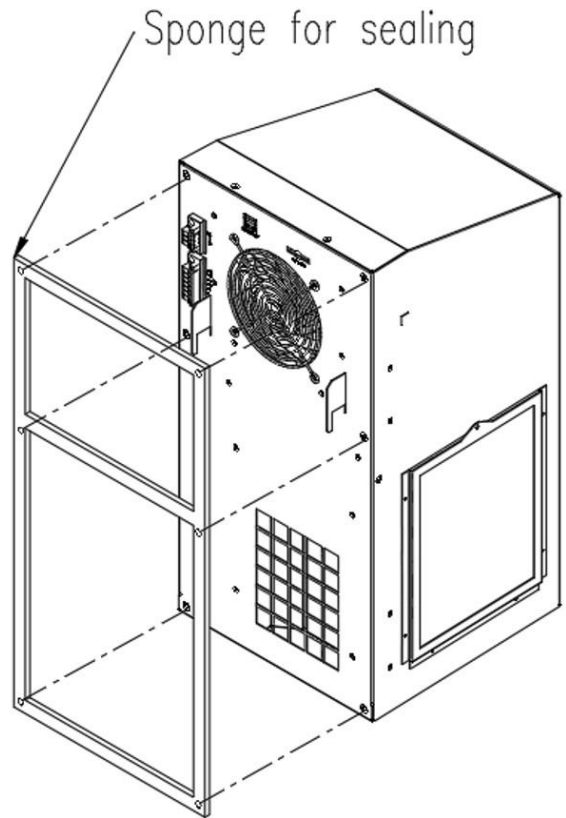
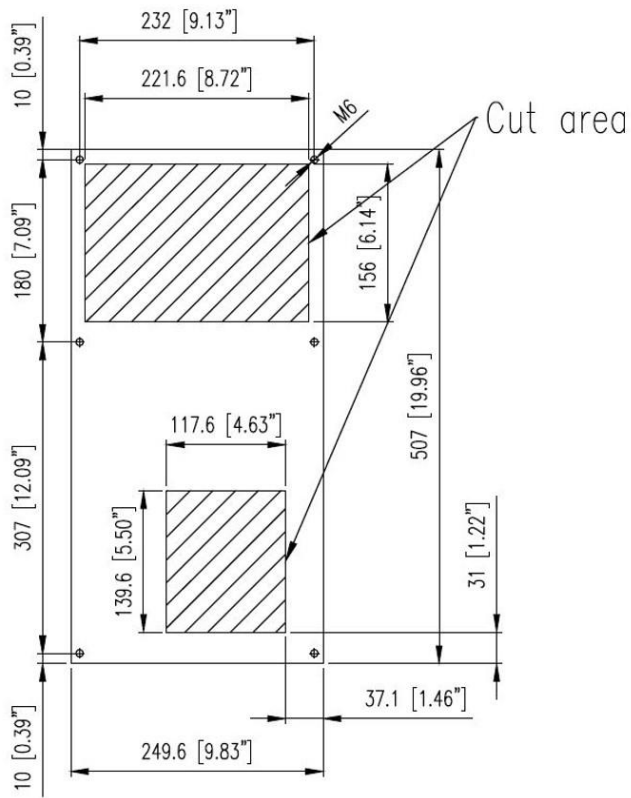

mm (inch)

Part no.:

Delta model no.: HEC0600AFS

### 1-5. Configuration & Maintenance

Make sure the air conditioner surface sealed with mounting flange to avoid water penetrates into shelter through mounting interface. It is suggested to use gaskets sticking on the mounting flange and seal the gap between flange and cabinet with silicone gel during installation. There should be **NO** any gap surround gaskets to avoid water penetrates into enclosure.

The air conditioner is composed as the following key components: they are chassis, cover, controller, heat exchanger, blowers and compressor etc. It is **“not”** recommended that the user replace the compressor, evaporator, and the condenser by themselves; it may damage the system and getting injured.

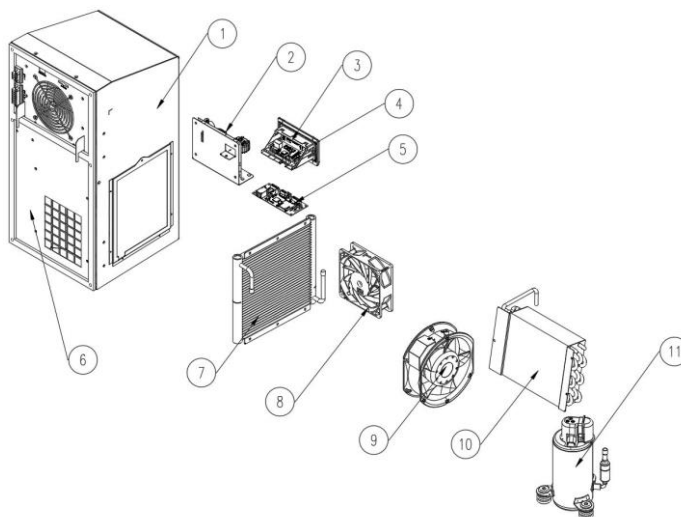

NO.	Q'TY	DESCRIPTION	Spare part P/N
1	1	Case Cover	N/A
2	1	Power Board	HEC0600AA-000C1
3	1	Display Board	HEC1000BFC-000C3
4	1	Control Board	HEC0600AA-000C2
5	1	Communication Board	HEC0600AFA-000C4
6	1	Case Chassis	N/A
7	1	Condenser	N/A
8	1	Internal Fan	HEC0600AFS-A00F1
9	1	External Fan	HEC0600AFS-A00F2
10	1	Evaporator	N/A
11	1	Compressor	N/A

Part no.:

Delta model no.: HEC0600AFS

---

In order to assure the air conditioner running at optimal condition, the condenser should be cleaned once annually at least; user can clean the condenser with water directly. The external side fan blade can also be cleaned with normal pressure water if there is dust accumulation. Please do not use strong water jet to impact the center of fan and the surface of condenser.

The bottom hole of the air conditioner should be connected to a sealed container through a drainpipe, please clear drain holes when the maintenance. Please also notice that:

1. Check wires are connected correctly, and the insulation is not cracking or broken.
2. Use Self-test to check the unit running correctly or not. And the supplied air of internal side should be as cooled air.
3. Do not wipe the product with organic solvent, volatile substances like toluene or gasoline, it will destroy the powder-coated surface.
4. Turn off the power before maintaining.
5. Please turn off power and remove dry contact connector while non-operating for a long time.
6. If any abnormal acoustic noise from air conditioner happened, please turn off the product and contact with customer services.
7. The refrigerant is environmental friendly product of R134a. Little refrigerant leakage (< 5 g/ year) is allowed for application. If refrigerant leakage seriously, please turn off the power and wait for at least 2 hours to make sure the refrigerant fully exhaust. Please also contact the services to replace spare parts.
8. The compressor electrical protecting cover is sealed with silicon for UL TYPE 4X requirement. Please do not dismantle the sealed cover or will lose the quality assurance of the compressor.

### 1-6. Thermal and Airflow

Internal and external air flow circulation is shown in below diagram. Counter flow design prevents mixing of internal and external air flows, but waste heat can still be dissipated from cabinet to the ambient outside air. An internal temperature sensor has been placed in the return air stream to provide reliable temperature measurement, and for safe operation.

The heated air inside the cabinet will be cooled by the evaporator. Waste heat absorbed by the refrigerant will be dissipated through the condenser at the external side.

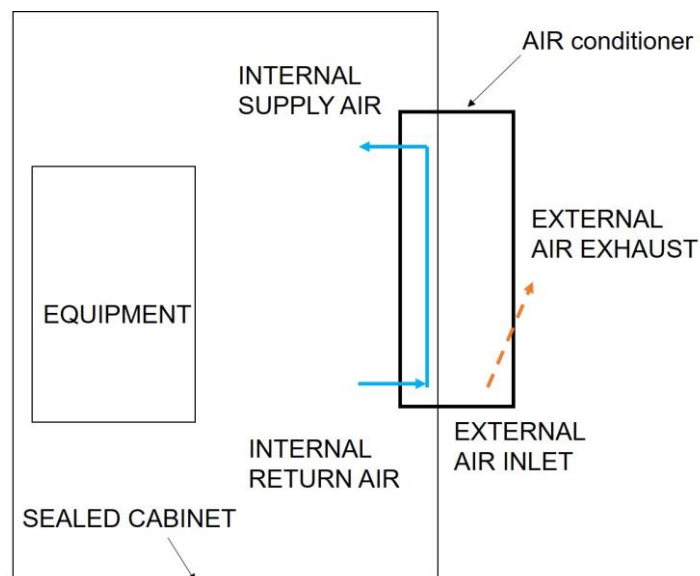

Part no.:

Delta model no.: HEC0600AFS

## 2. Electrical Specification

### ➤ Power Supply & Alarm Connector & Indicator

(1) AC Power Connect :

Pin	Description	Cable wire size
1	PE	18 AWG
2	N	18 AWG
3	L	18 AWG

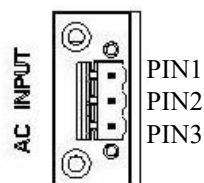

(2) RS485 and J1 Connect :

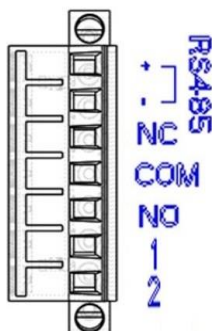

J1 Pin Name	Description
RS485 +	RS485 Communication
RS485 -	RS485 Communication
NC	Dry Output NC
COM	Dry Output COM
NO	Dry Output NO
1	Door open alarm input
2	Door open alarm input

### ➤ System Alarm Default Setup

- Specification: Contact rating: 2A@30 VDC / 2A@250 VAC
- Normal: NC and COM dry contact output close
- Alarms happening: NC and COM dry contact output open

(Dry Contact will trigger when alarm happen except E2.6 and E5.1)





Part no.:

Delta model no.: HEC0600AFS

---

(3) Panel operation :

- A: Display:

	7-Segment Display
 STATUS	Status LED
	Up
	Down
	Parametric Setup

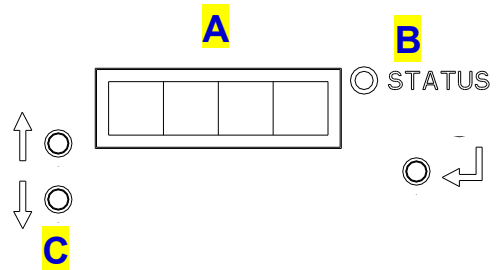

It will show the temperature inside the cabinet and system parametric setup.

- B: LED indicator:
  - ❖ When the system power on and the LED will light in green.
  - ❖ If any alarm happens, according to flashing times of red led to check the root cause.
  - ❖ If the system gets into self-test mode and the LED will flash in green.
- C: Press Buttons:
  - ❖ ↑: UP or increase
  - ❖ ↓: DOWN or decrease
  - ❖ SET: Parametric setup

(4) Panel Operation Flowchart :

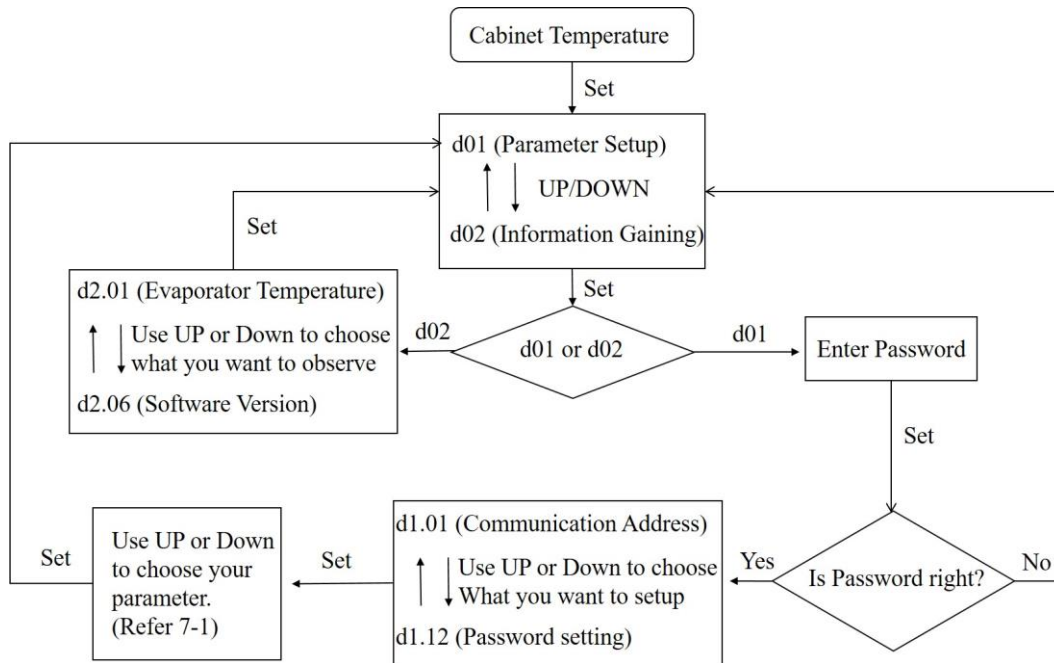

- ※ If no button is pressed, after 20 seconds, the panel will return to the Cabinet Temperature screen.
- ※ The default value of Password is 0001.

➤ **SD card & Ethernet (Optional function):**

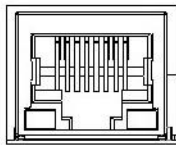

ETHERNET

SD CARD

The controller used communication technology to remotely control, monitor, SD card 8 GB for logging data and alarm the cooling function of the ACU. This can be done using a RJ45 or RS485 connected to an industrial network or a personal computer (PC) connected to an Internal local area network.



Part no.:

Delta model no.: HEC0600AFS

### 3. Environmental Condition

- **Operating Temperature**  
-10°C ~ +55 °C (14 °F ~ +131 °F)
- **Storage Temperature**  
-40 °C ~ +70 °C (-40 °F ~ 158 °F)
- **Operation Humidity**  
External air loop: 0 ~ 100 % RH  
Internal air loop: 0 ~ 80 % RH, non-condensing
- **Ingress Protection Rating**  
UL TYPE 12

### 4. Reliability Table

Test item	Condition
High temperature	IEC 60068-2-2
Low temperature	IEC 60068-2-1
High temp. / High humidity	IEC 60068-2-3
Temperature cycle	IEC 60068-2-14 test Nb
Vibration	ETSI 300 019-1-4 CLASS 4.1
Ingress protection (external side)	IP55 , UL TYPE 4X
Salt fog test (external side)	IEC 60068-2-52, 6cycles
Package bump	IEC 60068-2-29

### 5. Safety Certification

### 6. Accessory

Power and Alarm Cable :

Pin	Description	Cable wire size
1	PE	18 AWG
2	N	18 AWG
3	L	18 AWG

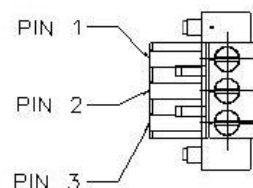

Part no.:

Delta model no.: HEC0600AFS

## 7. Parameters

### 7-1 Parametric Setup

Display	Description	Range
<b>d01</b>		
d1.01	Communication Address	1~128, (Default=21)
d1.02	Communication speed (Baud rate)	0 : 9600 1 : 19200 (Default=0)
d1.03	Compressor turn on temperature setting	20~50, (Default=40)
d1.04	Compressor hysteresis set point setting	1~10, (Default=5)
d1.05	Cabinet over temperature point setting	20~80,(Default=65)
d1.06	System self-test	0: off 1: on (Default=0)
d1.07	Door open alarm function	0: Disable 1: Enable (Default=1)
d1.08	Dry contact setting	0: normal Open 1: normal Closed (Default=1)
d1.09	System parameters recovery	0: off 1: on (Default=0)
d1.10	Heater turn on temperature setting	N/A
d1.11	Heater hysteresis set point setting	N/A
d1.12	Password setting	Default= 0001
<b>d02</b>		
d2.01	Evaporator temperature	Display
d2.02	Condenser temperature	Display

Part no.:

Delta model no.: HEC0600AFS

d2.03	Ambient temperature	Display
d2.04	Internal fan speed	NA
d2.05	External fan speed	NA
d2.06	Firmware version	Display

※ d1.10 and d1.11 are option functions. Default is closed.

※ d2 layer is for system status information read only.

## 7.2 Self-Test

1. Press the SET button into parametric setup mode.
2. Press UP button to choose d1.06 and then press SET button to choose “1”executing auto self-test.
3. If the system gets into self-test mode and LED will flash in green.
4. Auto self-test running period about eighty seconds exclude compressors three minutes protection.
5. The test process including EEPROM, NTC sensor, inner-fan, outer-fan, compressor heater, emergency fan running correctly.
6. Recognizing that the implementation process without generating alarm or fault. If any alarm happens, according to alarm code to check the root cause.

## 7.3 Alarm Logs & Fault Processing

Alarm Items	Type of alarm	Alarm code
Temperature protection alarm	Evaporator low temperature alarm	E 2.1
	Cabinet high temperature alarm	E 2.2
	System high pressure alarm	E 2.4
	System high pressure frequent alarm	E 2.5
	Cabinet low temperature alarm	E 2.6
Temperature sensor abnormality	Cabinet temperature sensor fault alarm	E 3.1

Part no.:

Delta model no.: HEC0600AFS

	Evaporator temperature sensor fault alarm	E 3.2
	Condenser temperature sensor fault alarm	E 3.3
	Ambient temperature sensor fault alarm	E 3.4
Control board exception	EEPROM abnormal alarm	E 5.1
System exception	Compressor failure alarm	E 6.2
	Door Open Alarm	E 6.3

Part no.:

Delta model no.: HEC0600AFS

### Fault Analysis and Processing

Fault State	Analysis of the Reasons	Solutions
Power on, and the cabinet temperature is too high but the air conditioner is not working	<ol style="list-style-type: none"><li>1. Power failure or no power.</li><li>2. The target temperature is higher than inside temperature.</li><li>3. System failure.</li></ol>	<ol style="list-style-type: none"><li>1. Check the power supply and the electric circuit.</li><li>2. Re-set the target temperature according to the system requirement.</li><li>3. Please contact the service department.</li></ol>
The air conditioner is running but the cabinet temperature is still high, no obvious cooling effect.	<ol style="list-style-type: none"><li>1. The air conditioner capacity is not match the load of the system.</li><li>2. The ambient temperature is too high.</li><li>3. Low efficiency of the condenser.</li><li>4. Other system failure</li></ol>	<ol style="list-style-type: none"><li>1. Check the heating load of the system.</li><li>2. Ensure the air conditioner operates in correct temperature range.</li><li>3. Clean the condenser.</li><li>4. Please contact the service department.</li></ol>
The air conditioner stop operating, and there is no alarm signal.	<ol style="list-style-type: none"><li>1. The inside temperature is lower than the target temperature.</li><li>2. Other system failure.</li></ol>	<ol style="list-style-type: none"><li>1. Re-set the target temperature according to the system requirement.</li><li>2. Please contact the service department.</li></ol>

Part no.:

Delta model no.: HEC0600AFS

## 8. Installation Notice

Check the surrounding obstacles to make sure the product get enough space for air circulate.

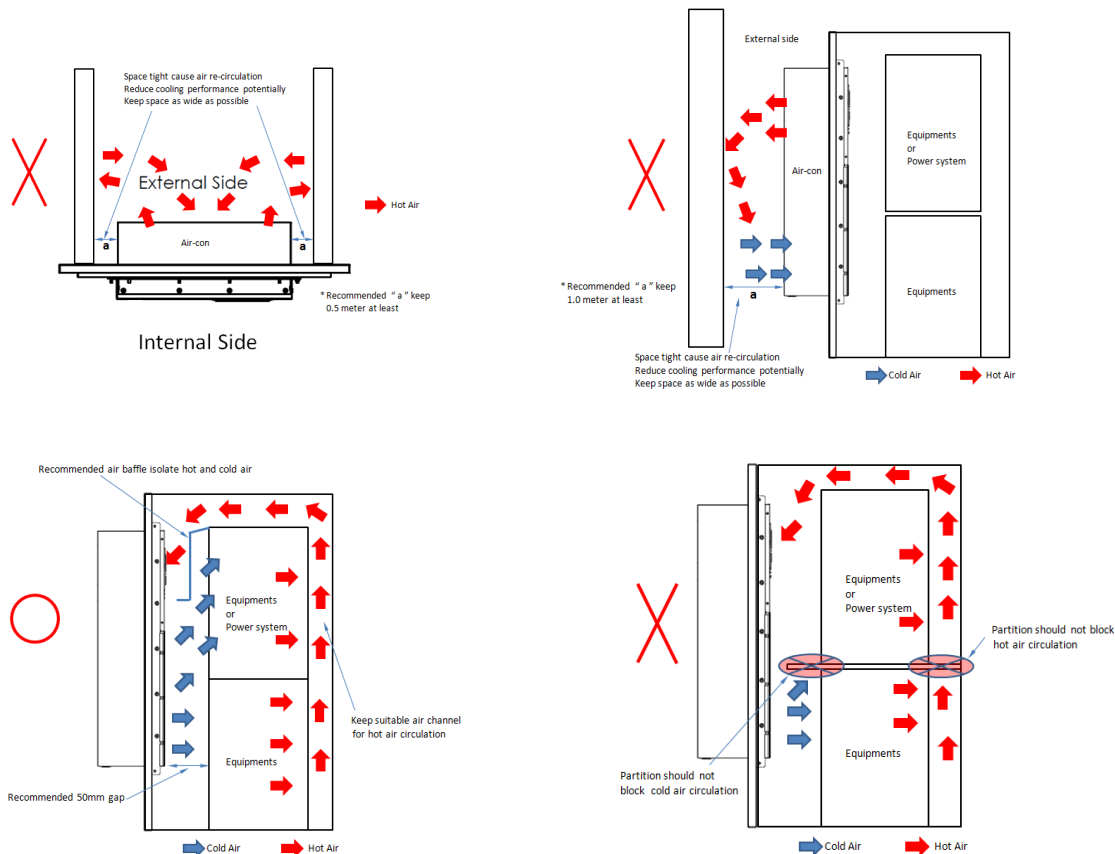

## 9. Reclaim



At the end of the unit working life, the produce must not be disposed of as urban waste. It must be taken to a special local authority differentiated waste collection center or to a dealer providing this service.

Part no.:

Delta model no.: HEC0600AFS

## 10. Versions

REV.	DESCRIPTION	DRAWN	CHECKED			APPROVED	ISSUE DATE
			ME	EE	CE		
00	ISSUE SPEC	Rick.Zheng 04/16'20	Rick.Zheng 04/16'20	Allen.Huang 04/16'20	-----	Diamond CHEN / MARS.WU 04/16'20	04/16'20
01	Add spare part P/N	Rick.Zheng 07/30'20	Rick.Zheng 07/30'20	Allen.Huang 07/30'20	-----	Diamond CHEN / MARS.WU 07/30'20	07/30'20
02	Remove the Caution second item	Rick.Zheng 09/02'20	Rick.Zheng 09/02'20	Allen.Huang 09/02'20	-----	Diamond CHEN / MARS.WU 09/02'20	09/02'20